

## Component Checklist

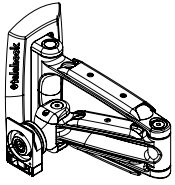

Articulated Arm

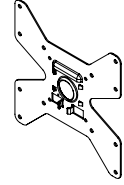

VESA Plate

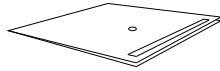

Drill Guide

### Tools Required:

- Power Drill
- 6mm (0.25") Drill Bit
- 10mm (0.4") Masonry Drill Bit
- Phillips-head Screwdriver
- 13mm (0.5") Socket Wrench or Shifter

### Hardware



Coach Bolt (x2)



Concrete Anchor (x2)



M4/5 Spacer (x4)



Security Screw (x1)



M4/M5 Washers (x4 each)



M6/8 Spacer (x4)



3mm Allen Key

### Display Mounting Screws



M4x16/25mm (x4 each)



M5x16/25mm (x4 each)



M6x16/30mm (x4 each)

## IMPORTANT INFORMATION:

**! IMPORTANT - Install Telehook 1040 Flat Screen Wall Mount as per Installation Instructions.**

! This product supports a maximum load of 25kg (55lbs).

! This product supports VESA mounting hole configurations: VESA plate, 75x75mm, 100x100mm, 200x100mm, and 200x200mm.

! The manufacturer accepts no responsibility for incorrect installation.

## Step 1. Check Components

Check you have received all parts against the component checklist and Hardware above.

## Step 2. Locate Drilling Position

Choose the location of your Telehook Wall Mount, ensuring that the wall is structurally sound (for a timber stud wall, locate the stud using a stud detection device). Use the Drilling Guide to mark out the hole centres.

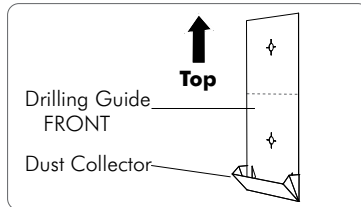

Un-fold the Drilling Guide and open the Dust Collector.

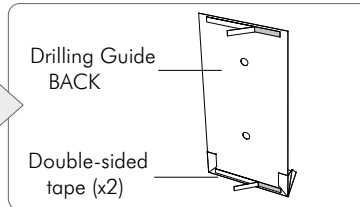

Peel away the backing from the double-sided adhesive tape.

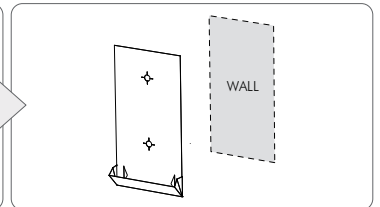

Position the Drilling Guide vertically onto the wall using a Spirit Level.

## Step 3. Attaching the Articulated Arm to the Wall

Remove the Telehook Arm from the packaging and open fully.

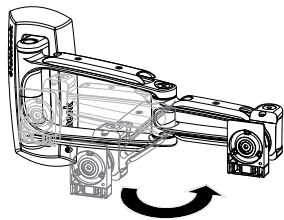

Un-clip the Wall Plate Cover and slide down the arm.

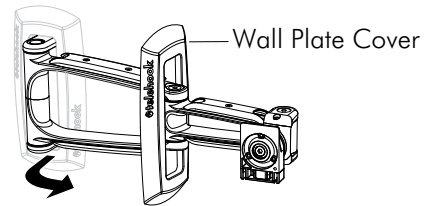

### Timber Stud Wall

- Drill two 6mm (0.25") diameter holes, 50mm (2") deep.
- Secure the Mounting Plate to the wall using the Coach Bolts supplied.

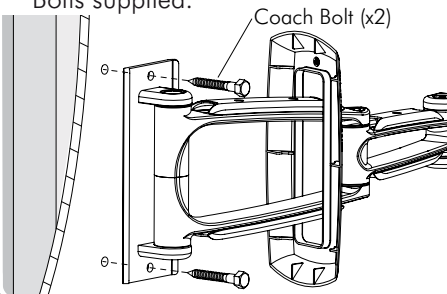

### Masonry Wall

- Drill two 10mm (0.4") diameter holes, 50mm (2") deep.
- Secure the Mounting Plate to the wall using the Coach Bolts and Concrete Anchors supplied.

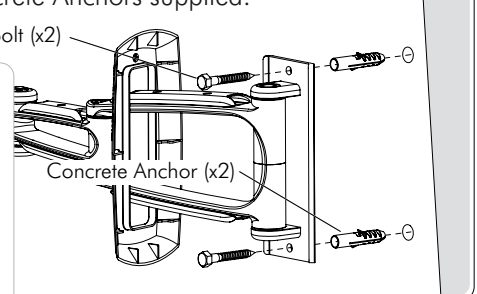

Slide the Wall Plate Cover back along the arm, and push flat against the wall.

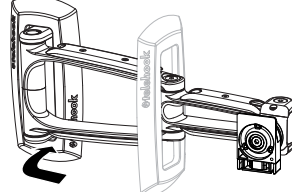

## Step 4. Attaching the VESA Plate to your Display

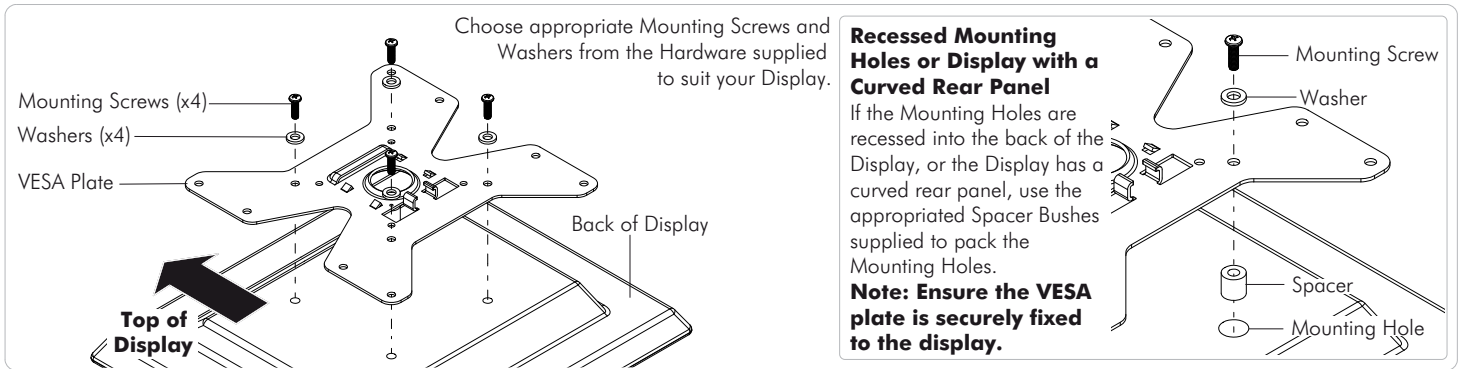

## Step 5. Attaching your Display to the Arm

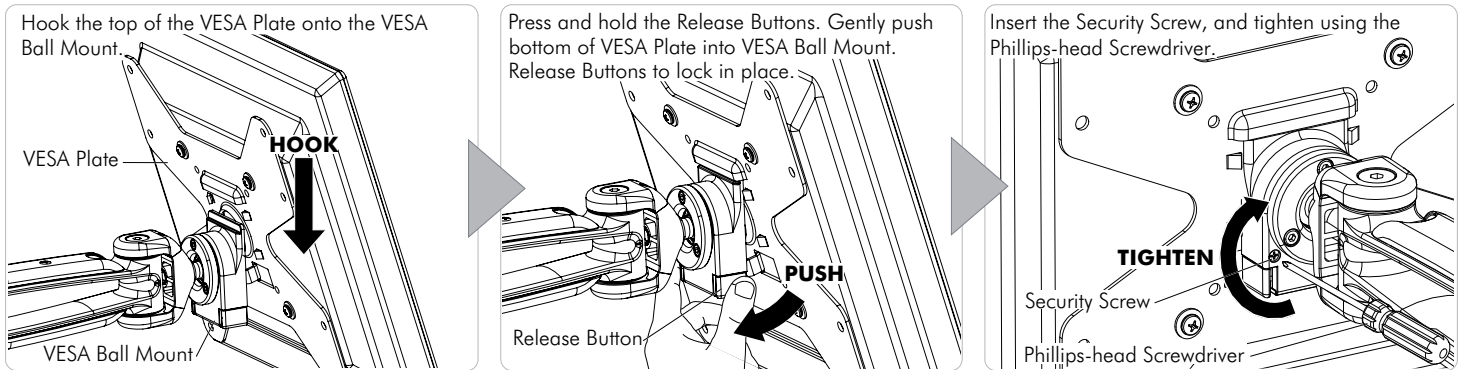

## Step 6. Cable Management

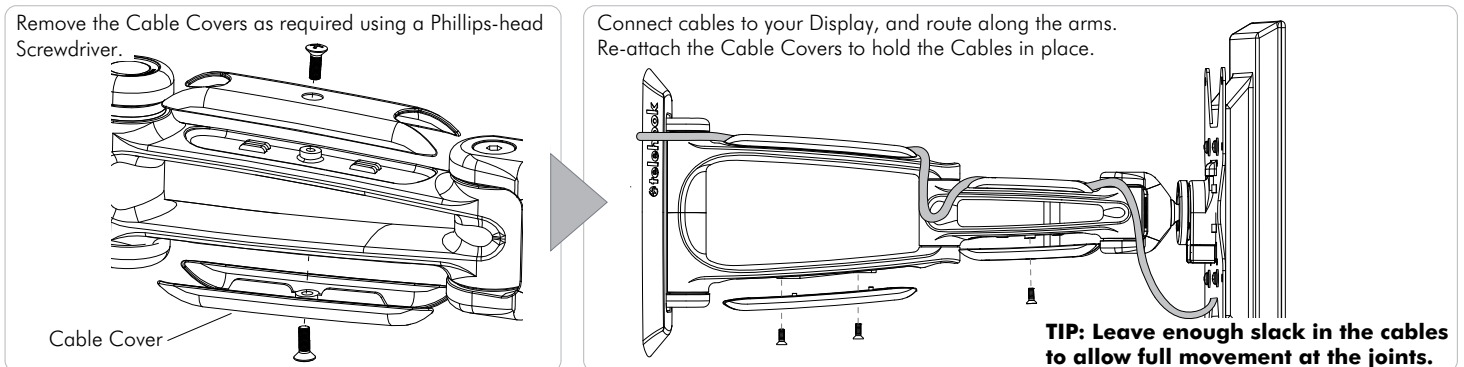

## Step 7. Final Adjustment

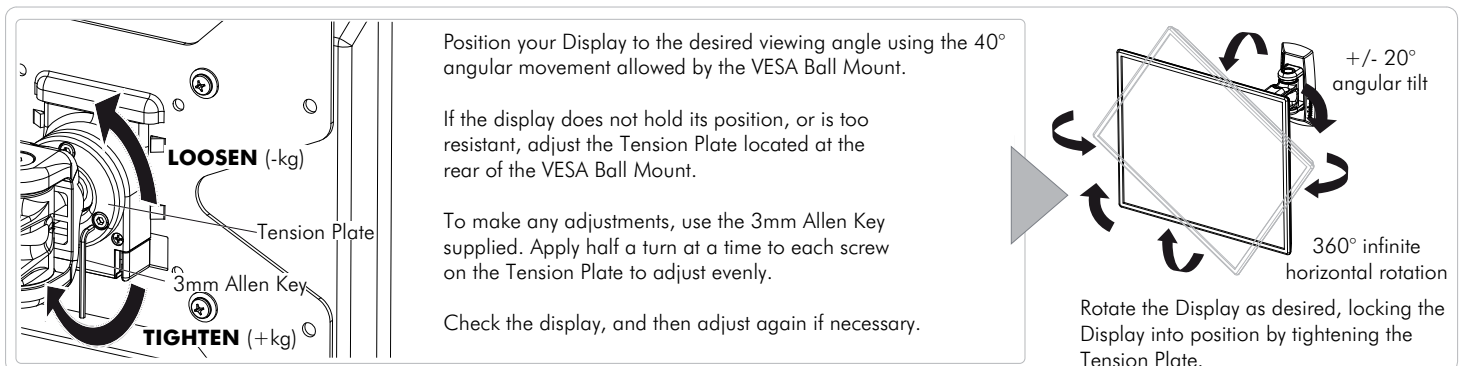

## Installation Complete

